

Exhaust System Installation Instructions for PN-140406



These instructions have been written to help you with the installation of your Borla Performance Exhaust System. Please read this document completely before beginning the installation of your system.

Please compare the parts in the box with the bill of materials provided to assure that you have all the parts necessary for this installation.

To ensure this part number fits your specific model year, please visit our website for the latest model year listings at www.BORLA.com.

Thank you for purchasing a Borla Performance Cat-Back™ Exhaust System.

This Borla Performance Cat-Back™ Exhaust System (140406) is designed for the Jeep Grand Cherokee each equipped with a 5.7L V8 engine, 4-wheel drive and automatic transmission.

Borla Performance Industries recommends that an exhaust shop or professional after market parts installer perform the installation of this system. However, if you decide to perform the installation on your own it is recommended that two people are used. This installation should not be performed by one person due to the risk of injury. Ensure the installers use all under car safety precautions including eye protection.

Please take time to read and understand the following...

By installing your Borla Performance Exhaust System, you indicate that you have read this document and you agree with the terms stated below.

It is the responsibility of the purchaser to follow all installation instruction guidelines and safety procedures supplied with your Borla Performance Exhaust System

Borla Performance Industries assumes no responsibility for damages occurring from misuse, abuse, improper installation, improper operation, lack of responsible care, or all previously stated reasons resulting from incompatibility with other manufacturer's products and/or systems.

Included with your Borla Performance Exhaust System is a warranty card. Please read it carefully before you begin any work on your vehicle. If you should have any questions regarding our warranty policy, installation, or any other matter pertaining to your new Borla Performance Exhaust System, please give us a call at the number provided on the warranty card.

Minimum Required Tool List:

TOOLS:

1. 3/8" Drive Ratchet
2. 3/8" Drive Extension 3"
3. 15mm Deep Well Socket
4. Torx socket
5. Pry Bar

SHOP SUPPLIES:

- 1 Spray Lubricant

Borla Performance Cat-back™ - Bill of Materials

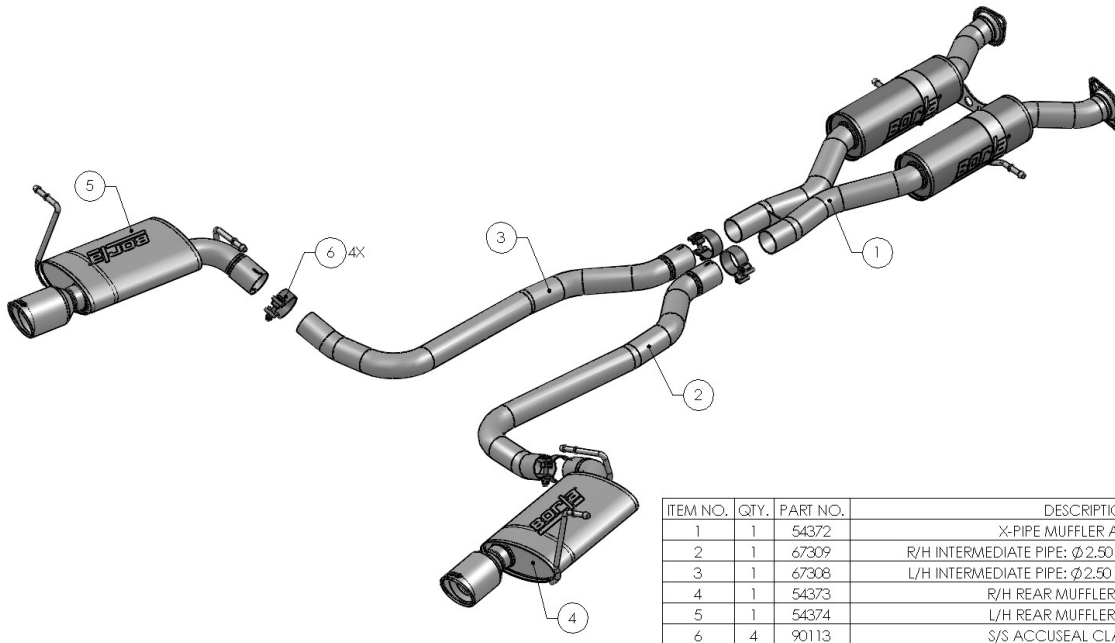

ITEM NO.	QTY.	PART NO.	DESCRIPTION
1	1	54372	X-PIPE MUFFLER ASSEMBLY
2	1	67309	R/H INTERMEDIATE PIPE: Ø 2.50 X 45.50" (FROM 80027)
3	1	67308	L/H INTERMEDIATE PIPE: Ø 2.50 X 45.50" (FROM 80027)
4	1	54373	R/H REAR MUFFLER ASSEMBLY
5	1	54374	L/H REAR MUFFLER ASSEMBLY
6	4	90113	S/S ACCUSEAL CLAMP Ø 2.50

Caution!!! Never work on a hot exhaust system. Serious injury in the form of burns can result If the vehicle has been in use and the exhaust system is hot, allow vehicle to cool for at least 1 hour. Always wear eye protection when working under any vehicle.

Note: It is our recommendation that you use a hoist or hydraulic lift to facilitate the installation of your new Borla Performance Rear Section Exhaust System.

Taking all under car safety precautions, lift the vehicle using a hoist or hydraulic lift. Once this has been done, you may begin the removal of your old exhaust system from your vehicle.

Note: Before removing the original exhaust system from your vehicle, please compare the parts you have received with the bill of materials provided on the previous page to assure that you have all the parts necessary for the installation of your new Borla Performance Rear Section Exhaust System.

Original Exhaust System Removal

Note: With a used vehicle, we suggest a penetrating spray lubricant to be applied liberally to all exhaust fasteners and allowing a significant period of time for the chemical to lubricate the threads before attempting to disassemble.

1. Lubricate all hangers and rubber isolators.
2. Loosen and remove nut, washer and spring on front flanges. Keep hardware for installation of your new exhaust system. (See Fig.1)
3. Loosen the hardware on the left-rear muffler and carefully remove the muffler from the hangars. Repeat for the right-side rear muffler.
4. Using a muffler stand or an additional person to hold the exhaust system in position, remove the hangers from the rubber isolators and remove the remaining exhaust system from the vehicle. (See Figs.2 & 3)

Warning: Use extreme caution during installation. Torque all fasteners according to manufacturer's torque values and tightening sequence. DO NOT use air impact tools to tighten fasteners on Borla Performance Exhaust Systems. Use of such tools may result in bent flanges or gasket contact areas leading to exhaust leaks.

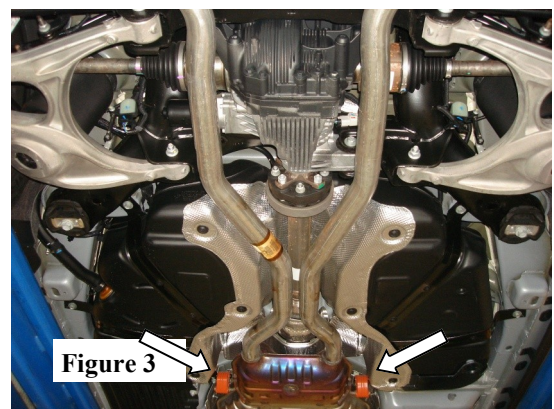
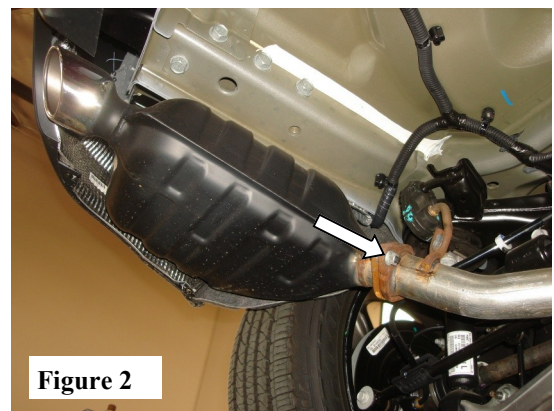
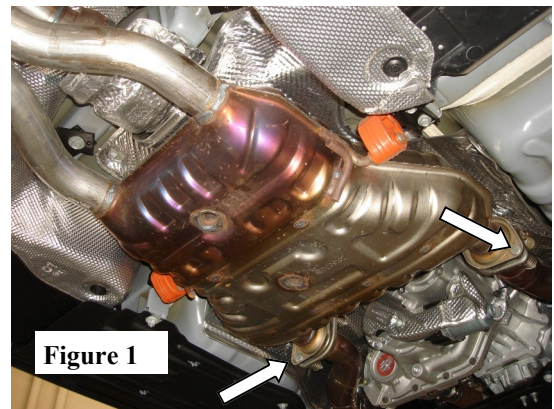

Borla Performance Cat-Back™ Exhaust System Installation

1. Using the original hardware, place the X-Pipe Muffler Assembly into position making sure to install the hangers into the rubber isolator. Hand tighten the flange making sure the original hardware is oriented as shown. (See Fig. 4)
2. Place a clamp over the expanded end of the Right-Hand Intermediate Pipe and set it into position. (See Fig. 5). Do Not tighten the clamp.
3. Place a clamp over the expanded end of both left and right intermediate pipes and set them into position making sure to install the hangers into the rubber isolators. (See Fig. 6) Do Not tighten the clamps.
4. Install the hanger/bracket assembly on driver side frame rail located at the rear of vehicle. Install the rubber isolator onto the hanger/bracket assembly. (See Fig. 7)
5. Place a clamp over the expanded ends of both left and right tail pipe assemblies and set them into position making sure to install the hangers into the rubber isolators. Do Not tighten the clamps.
6. Check your exhaust system for proper clearance under the vehicle and also for tip alignment.
7. Once position has been determined to be correct, tighten the flange hardware to 18-22 ft. lbs. and the Accuseal clamps to 32-35 ft. lbs. making sure the clamp opening is not over any of the notches in the pipe.
8. Before starting your vehicle, make sure to check all wires, hoses, brake lines, body parts and tires for safe clearance from the exhaust system.
9. Start vehicle and check for any leaks. If any leaks are found, determine cause (such as loose or incorrectly positioned clamp) and repair as necessary.

Note: When you first start your vehicle after the installation of your new Borla Performance Exhaust System, there may be some smoke and fumes coming from the system. This is a protective oil based coating used in the manufacturing of mandrel bent performance exhaust tubing. This is not a problem and will disappear within a very short period of time after the exhaust has reached normal operating temperatures.

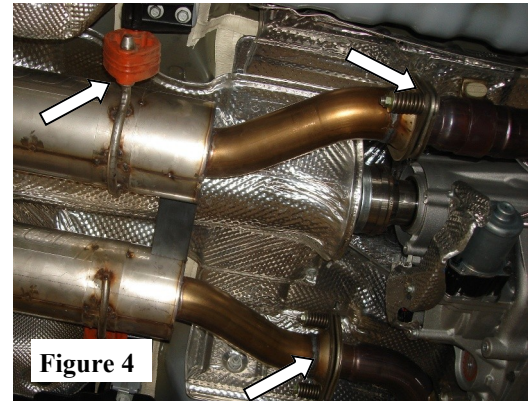

Figure 4

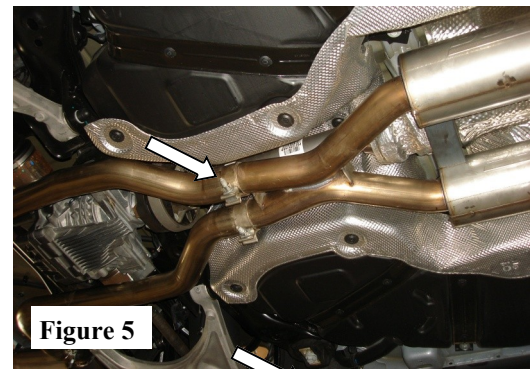

Figure 5

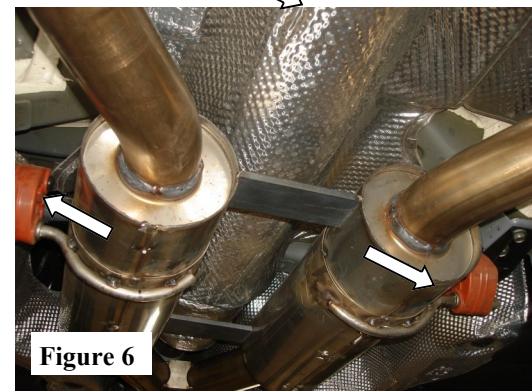

Figure 6



Figure 7