



Edelbrock E-Force Supercharger

2005-10 6.1L HEMI / 2006-10 5.7L HEMI

Part #1530, 1531, 1532, 1533, 1536 & 1537



Edelbrock Hemi Supercharger System 2005 - 2010 Dodge/Chrysler Vehicles

Installation Instructions

INTRODUCTION

Thank you for purchasing the Edelbrock Hemi Supercharger System for various Chrysler/Dodge vehicles. The Edelbrock E-Force Supercharger System for the 2005 to 2011 Hemi utilizes Eaton's new Gen VI TVS Supercharger rotors, featuring a four lobe design with a full 160° of twist for maximum flow, minimum temperature rise, quiet operation, and the reliability for which Eaton is known. The Edelbrock Supercharger is a complete system that maximizes efficiency and performance by minimizing air restriction into, and out of, the supercharger. This results in maximum airflow, with minimal temperature rise and power consumption. The supercharger housing itself is integrated into the intake manifold for a seamless design with minimal components, eliminating the possibility of vacuum leaks between gasket surfaces. The system also utilizes a front drive, front inlet configuration giving it the shortest, least restrictive inlet path on the market. The supercharger is inverted, expelling the air upward. Air pressure then builds in the plenum, before being pushed through the intercooler, oriented horizontally, above the supercharger outlet. After passing through the intercooler core, the air travels through the long runners, which route straight down into the cylinder head ports. This configuration allows for a compact package that can fit under the stock hood and cowl of the vehicles for which it was designed, without sacrificing runner length, or intercooler area. The E-Force supercharger features a uniquely styled plenum, and includes matching side covers. The Edelbrock supercharger provides neck snapping performance that is safe to operate on a completely stock engine. It can be had with an optional 5-year 100,000 mile warranty so that there are no worries when installing it on a brand new car.

TOOLS AND SUPPLIES REQUIRED

- Jack and Jack Stands OR Service Lift
- Panel Puller
- Ratchet and Socket Set including: 7mm, 8mm, 10mm (standard, deep and swivel), 11mm, 12mm (deep), 13mm, 15mm, 18mm, 21mm (deep), 24mm
- Wrenches including: 8mm, 18mm, 27mm
- 1/2" Breaker Bar
- Flat Blade & Philips Screwdrivers
- Compressed Air
- Allen Wrenches including: 5mm, 6mm, 8mm
- 4" Long 6mm Allen Socket
- Mechanic's Wire
- Chrysler Crank Pulley Installation Tool #8512A OR Equivalent
- Chrysler Fuel Pump Lock Ring Remover/Installer #9340 OR Equivalent
- Side Cutters
- 3 Jaw Pulley Puller
- Chrysler tool #8513A or equivalent
- 3/8" & 5/16" Fuel Line Removal Tools
- Torque Wrench
- Needle Nose Pliers
- Pliers OR Hose Clamp Removal Tool
- Pneumatic or Power Drill
- Impact Wrench
- Blue & Green Loctite Retaining Compound or equivalent
- O-ring Lube
- Masking Tape



IMPORTANT WARNINGS

Before beginning installation, use the enclosed checklist to verify that all components are present in the box then inspect each component for damage that may have occurred in transit. If any parts are missing or damaged, contact Edelbrock Technical Support, not your parts distributor.



WARNING: Installation of this supercharger will result in a significant change to the performance characteristics of your vehicle. It is highly recommended that you take some time to familiarize yourself with the added power, and how it is delivered, in a controlled environment. Take extra care on wet and slippery roads, as the rear tires will be more likely to lose traction, with the added power. It is never recommended to turn off your vehicles traction control system.

Proper installation is the responsibility of the installer. Improper installation will void all manufacture's standard warranties and may result in poor performance and engine or vehicle damage.

Inspect all components for damage that may have occurred in transit before beginning installation. If any parts are missing or damaged, contact Edelbrock Technical Support, not your parts distributor.

Due to the complexity of the Edelbrock E-Force Supercharging system, it is recommended that this system only be installed by a qualified professional with access to a service lift, pneumatic tools, and a strong familiarity with automotive service procedures. To qualify for the optional supplemental warranty, it is necessary to have this system installed by a Certified ASE Technician at a licensed shop, Chrysler Dealership, or an Authorized Edelbrock Installer. Failure to do so will void and/or disqualify any and all optional supplemental warranties offered with this system. Please contact the Edelbrock Technical Support department if you have any questions regarding this system and/or how your installer of choice will affect any warranty coverage for which your vehicle may qualify.

Any previously installed aftermarket tuning equipment must be removed and the vehicle returned to an as stock condition before installing the supercharger.

Any equipment that directly modifies the fuel mixture or ignition timing of the engine can cause severe engine damage if used in conjunction with the Edelbrock E-Force Supercharger System. This includes, but is not limited to: ignition boxes, air/fuel controllers, OBDII programmers, and any other device that modifies signals to and/or from the ECU. Aftermarket bolt-on equipment such as underdrive pulleys or air intake kits will also conflict with the operation of the supercharger and must be removed prior to installation. Use of any of these products with the E-Force Supercharger could result in severe engine damage.

SRT8 Challengers and SRT8 Magnums using kit #1536 may need to modify or remove the under hood air duct as it may interfere with the E-Force Supercharger.



Edelbrock Hemi Supercharger System 2005 - 2010 Dodge/Chrysler Vehicles

Installation Instructions

IMPORTANT WARNINGS cont'd



91 octane or higher gasoline is required at all times. If your vehicle has been filled with anything less, it must be run until dry and refilled with 91 or higher octane gasoline twice prior to installation.

Any failures associated with not using premium 91 octane gasoline or higher, will be ineligible for warranty repairs.

Edelbrock periodically releases improved versions of the calibration file found on the supplied handheld programmer. Check the website to ensure you have the latest version, as described in the Test Flash Procedure on Page #9.

NOTE: *If you get the message on your Predator programmer that reads: "This vehicle needs an update Download here: www.diablosport.com/dcx." This is because the programmer needs to update the vehicle's stock calibration file because the vehicle currently has an older calibration that is not supported by the programmer, this does not mean that the programmer itself needs an update.*

Please go to www.diablosport.com/dcx and it will instruct you how to update the calibration for your vehicle. In order to do this calibration update you will need a Serial Cable or USB to Serial cable adapter that is not supplied.

Edelbrock Authorized Installer Disclaimer

Authorized installers of Edelbrock products are independent companies over which Edelbrock has no right of control. Edelbrock LLC makes no claims regarding the abilities, expertise or competency of individual employees of any authorized installer. Each authorized installer is an independent company and makes its own independent judgments. Edelbrock LLC specifically disclaims any responsibility to any party including third parties for the actions, or the failure to act, of individuals, agents or a company authorized in the installation of Edelbrock LLC products.



Installation Instructions

INSTALLATION HARDWARE IDENTIFICATION GUIDE (Not All Parts Are To Scale)

Bag #1



(4x) - M6 x 1.0 x 40mm Hex Flange Bolt



(12x) - M6 x 1.0 x 30mm Hex Flange Bolt

(1x) - Throttle Body O-Ring (Included, but not shown)

Bag #2



(1x) - M8 x 1.25 x 90mm Socket Head Bolt



(2x) - M8 x 1.25 x 20mm Hex Flange Bolt



(1x) - M8 x 1.25 x 75mm Socket Head Bolt



(2x) - M6 x 1.0 x 20mm Socket Head Bolt



(1x) - M10 x 1.5 x 45mm Countersunk Bolt



(1x) - M8 x 1.25 Hex Flange Nut



(2x) - M8 Washer



(1x) - M10 x 1.5 x 65mm Hex Flange Bolt



(1x) - M8 x 1.25 x 40mm Socket Head Bolt



(2x) - M6 x 1.0 x 40mm Hex Flange Bolt



(2x) - Spacer, 1.00"



(2x) - Nose Support Block

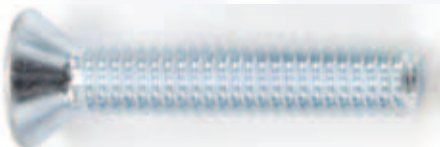

(1x) - M8 x 1.25 x 45mm Countersunk Bolt



Edelbrock Hemi Supercharger System 2005 - 2010 Dodge/Chrysler Vehicles

Installation Instructions

Bag #3



Bag #4





Edelbrock Hemi Supercharger System 2005 - 2010 Dodge/Chrysler Vehicles

Installation Instructions

Bag #5

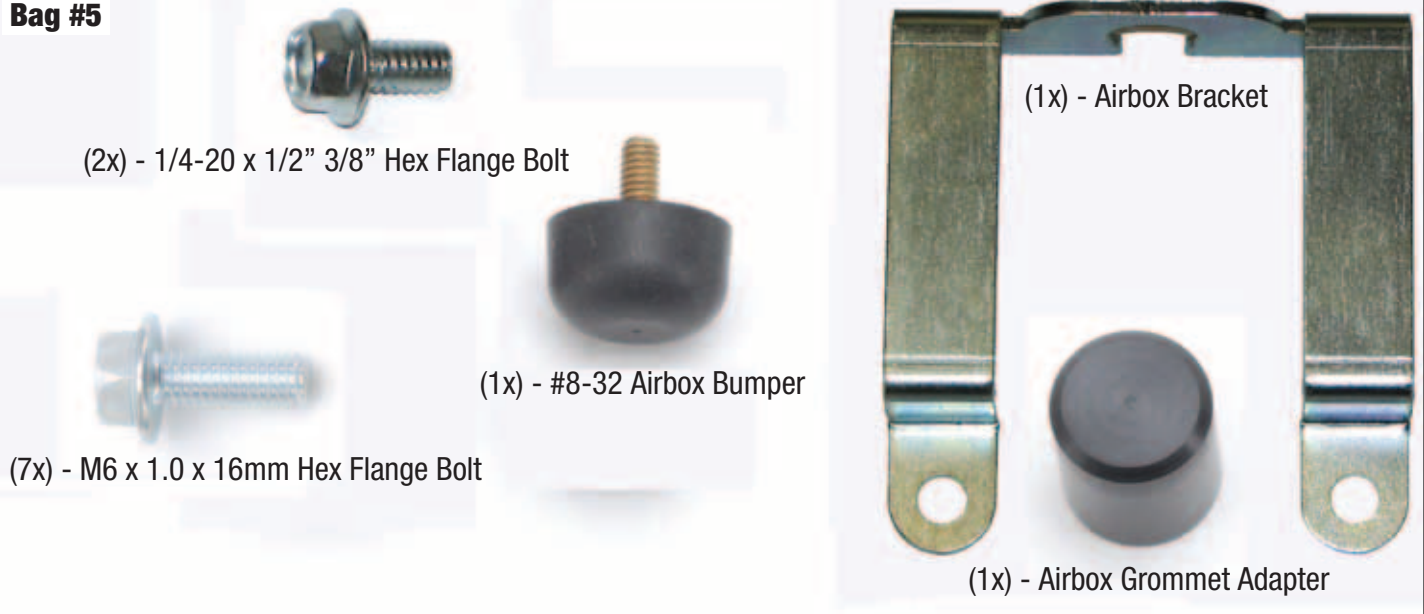

Bag #6

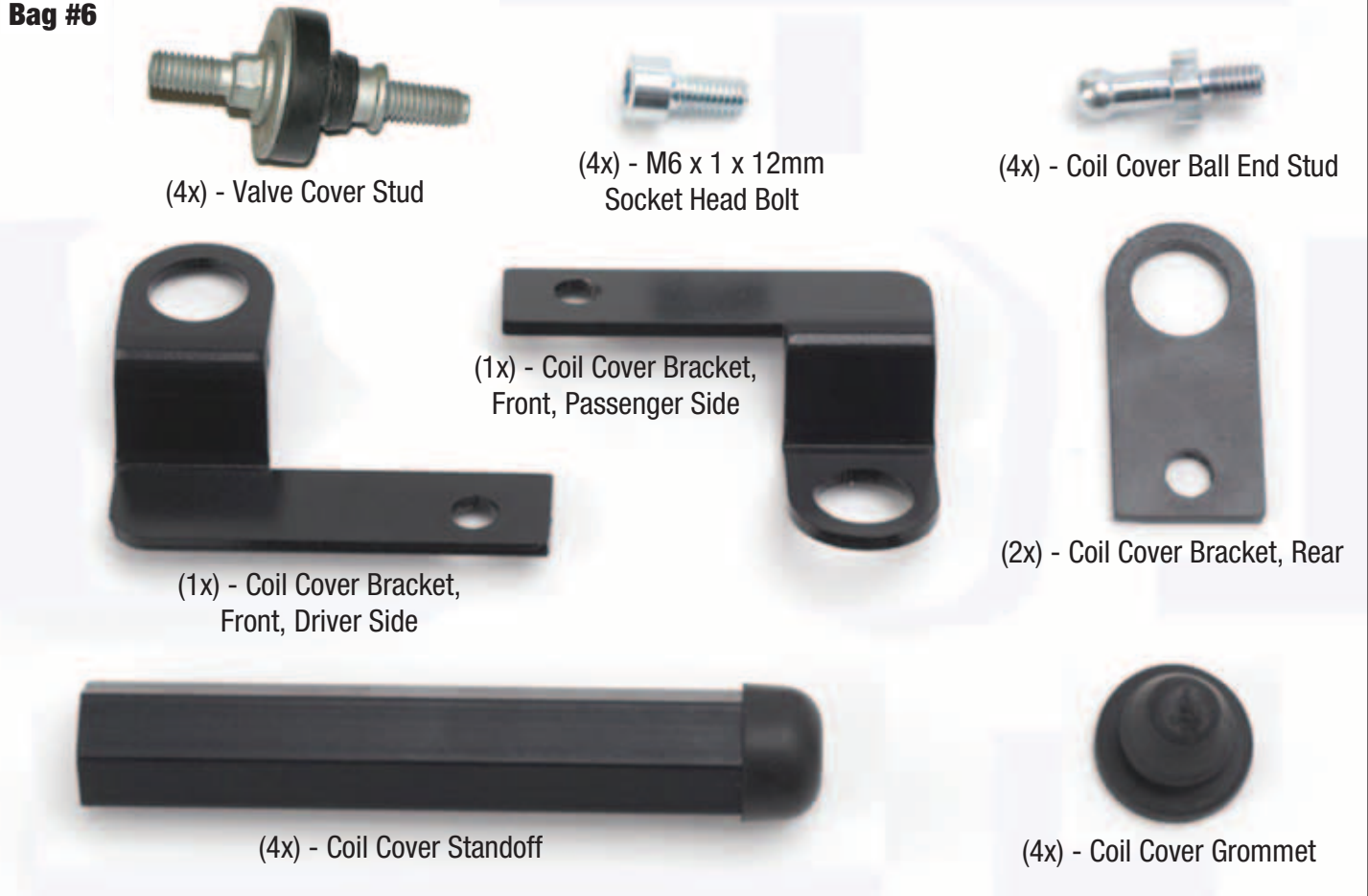



HOSE IDENTIFICATION GUIDE

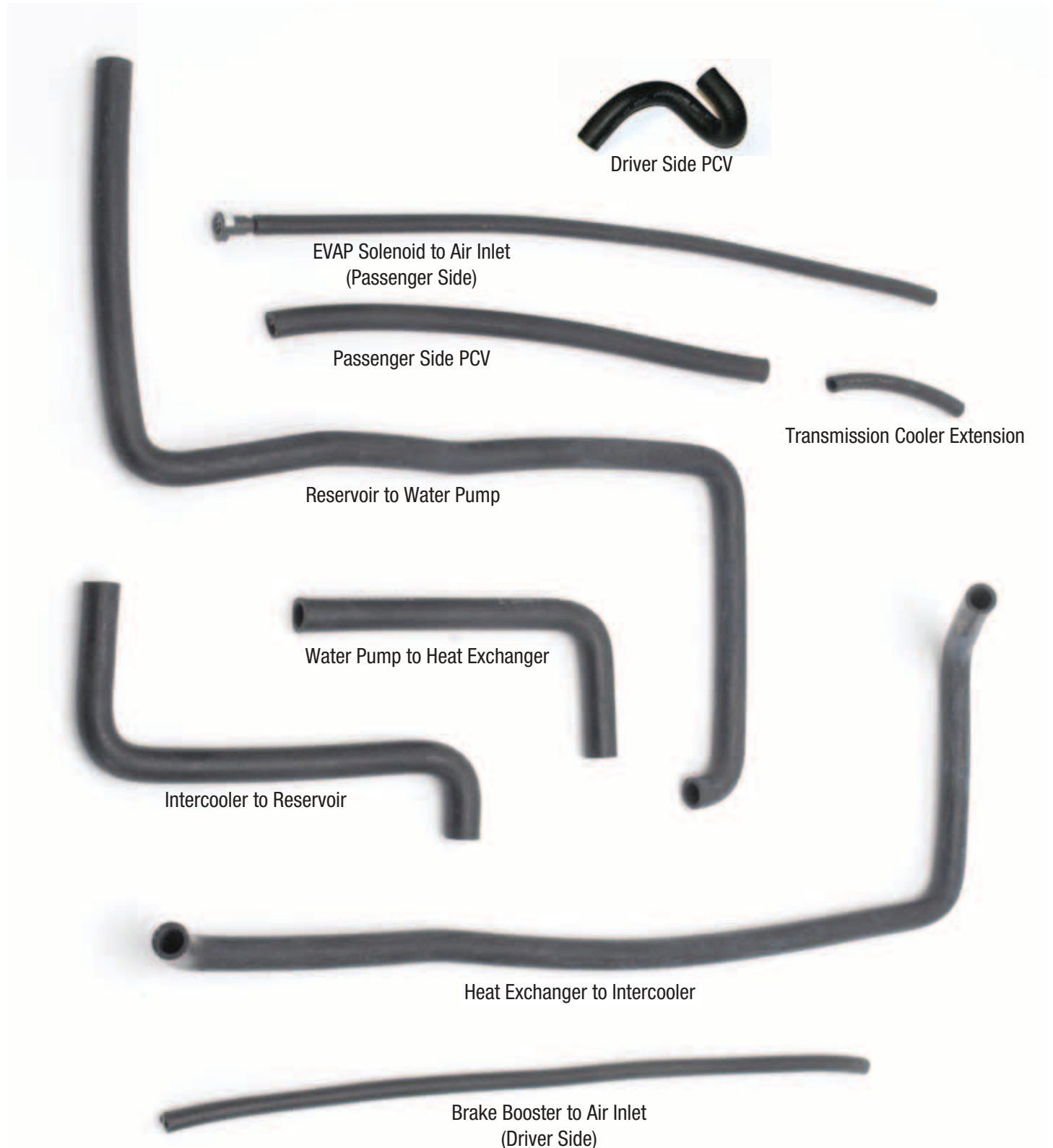



Edelbrock Hemi Supercharger System 2005 - 2010 Dodge/Chrysler Vehicles

Installation Instructions

WIRE HARNESS GUIDE

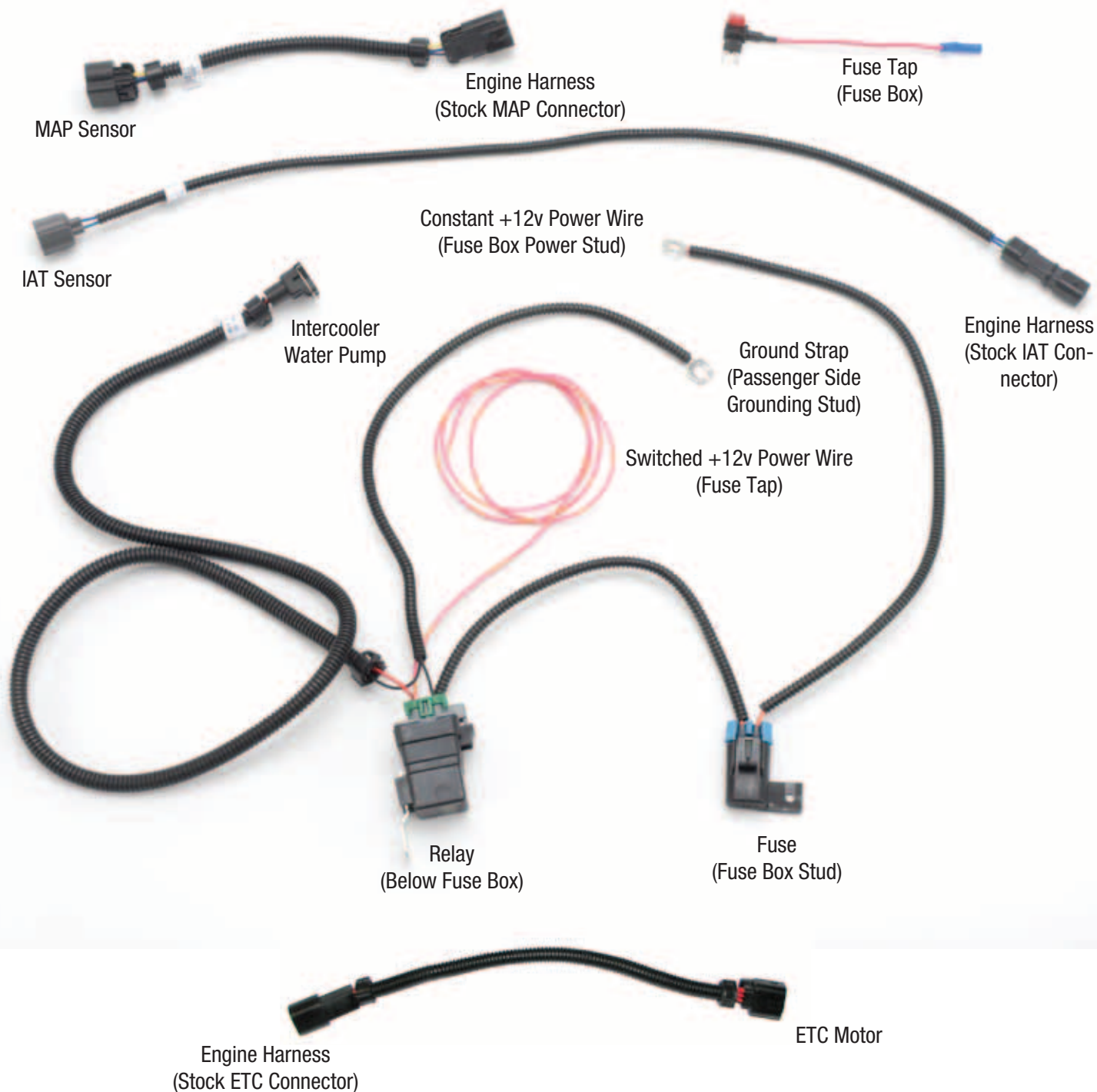

(1x) - IAT Sensor Extension Harness for 2010 5.7L. Only in kits 1532/15320/1533. *(Included, but not shown)*



Edelbrock Hemi Supercharger System 2005 - 2010 Dodge/Chrysler Vehicles

Installation Instructions

Test Flash Procedure

Verify that your vehicle's ECU & the supplied programmer are up to date, then use the programmer to flash the ECU thus verifying that they are compatible

- Original Equipment Manufacturers often release updates to the computer programming for your vehicle. Edelbrock highly recommends that you verify, with your new car dealer, that your vehicle is equipped with the latest software version from your vehicle manufacturer, before attempting to load the Edelbrock tune.
- Confirm that your programmer has the latest calibration by checking the Edelbrock website (http://www.edelbrock.com/automotive_new/mc/superchargers/software-tech.shtml). Once you have found the latest tune on the site, power on the programmer, press the left arrow and select the Device Info option. Scroll down to Tune Version and compare that number to the one on the site. If they are different, download the new calibration as instructed on the website.

NOTE: If you get the message on your Predator programmer that reads: *"This vehicle needs an update Download here: www.diablosport.com/dcx."*, this is because the programmer needs to update the vehicle's stock calibration file because the vehicle currently has an older calibration that is not supported by the programmer, this does not mean that the programmer itself needs an update.

Please go to www.diablosport.com/dcx and it will instruct you how to update the calibration for your vehicle. In order to do this calibration update, you will need a Serial Cable or USB to Serial cable adapter that is not supplied.

- Plug the supplied programming module into the OBD-II port of the car, located below the steering column.

- Once the main menu has loaded, press the central 'select' button on the controller to access the 'Performance Tune' option.

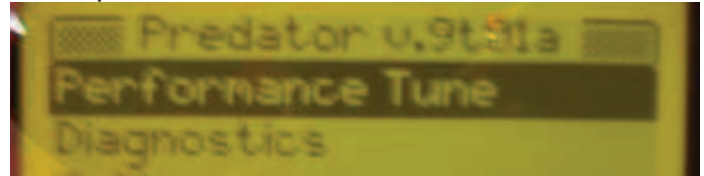

- Read the disclaimer carefully, then choose 'Agree' and press select.
- Use the arrow buttons to select your transmission, then press select to confirm your selection.
- Select 'Edelbrock E-Force 5psi' from the menu.
- Read the description and press select.
- The programmer will automatically save a copy of your existing engine tune. Press select to continue.
- Turn the ignition key to the 'OFF' position when prompted, but do not remove it.
- Turn the ignition key to the 'ON' position when prompted, but do not attempt to start the car. The programmer will automatically start saving the stock calibration.
- Once complete, follow the on-screen prompts regarding key position until you are given the option to 'Install Tune' or 'Modify Tune'. Choose 'Modify Tune' and press select.
- Read the disclaimer and press select.
- Select 'Modify Parameters' and press select.

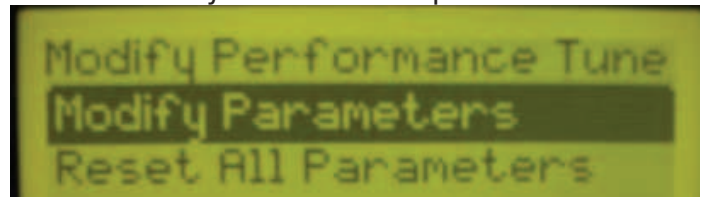

- Press select to choose 'Axle Ratio'.
- Press select to choose 'Axle Ratio', again.



Edelbrock Hemi Supercharger System 2005 - 2010 Dodge/Chrysler Vehicles

Installation Instructions

- Use the directional buttons to choose the number closest to your axle ratio (printed on the differential cover) and press select to confirm your choice.
- An asterisk will appear next to the 'Axle Ratio' option to signify that your changes have been saved. If your vehicle is equipped with non-stock tires, choose the 'Tire Revs per Mile' option and press select; otherwise, proceed to the next step.

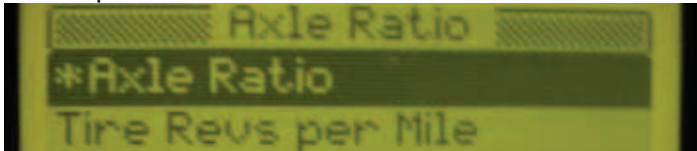

- You will need to check your tire manufacturer's website to determine the tire revolutions per mile for your tires.
- Use the directional buttons to select the number closest to the tire revs per mile figure provided by your tire manufacturer. Press select again to confirm your selection.
- Press escape twice to return to the Performance Tune menu.
- Choose 'Install Tune' and press select. Confirm your choice by pressing select.
- Follow the on-screen prompts regarding key position until you receive notification that the tune installation is complete.
- When the download is complete you will be prompted to disconnect the Diablo Sport Performance Tuner from the OBD-II port of your vehicle.

Post Successful Test Flash

- If you are ready to install the supercharger, proceed to Step 1 of the Supercharger Installation.

OR

- If you wish to return the ECU back to the factory calibration, such that the vehicle can still be driven until you are ready to begin the installation, then:
- Put the car into Acc mode, but don't start the vehicle.

- Connect the supplied PCM cable to the OBD-II connector.
- Use directional pad to highlight Program Vehicle option and press Select button.
- Use directional pad to highlight 'Diablo Tunes' and select then select the 'Original Backup' option.
- Follow the on screen instructions. Turn the car off when prompted to do so by the handheld programmer.
- Unplug the programmer cable from the OBD-II port when calibration is complete and when prompted to do so.
- When you are ready to Install the supercharger, proceed with Step 1 and you will be prompted to re-flash the ECU towards the end of the installation procedure.

Supercharger Installation

CAUTION - 5.7L Engine Only: This installation requires replacement of the in tank fuel pump. Before beginning the installation, make sure the fuel level of the vehicle is below 5/8 of a tank to avoid fuel spillage in vehicle.

NOTE: For vehicles driven competitively or in an aggressive manner, Edelbrock recommends the use of the following, colder, spark plugs:

NGK IX Iridium 6619 LFR6AIX-11 - 2009-2010 w/ 5.7L only (not included)

NGK IX Iridium 2315 LZTR6AIX-13 - All other models (not included)

For normal street driving, re-gapped stock equipped spark plugs are sufficient.

1. Use a 10mm wrench to loosen and remove the negative battery terminal.





Edelbrock Hemi Supercharger System 2005 - 2010 Dodge/Chrysler Vehicles

Installation Instructions

2. Use a 10mm wrench to loosen and remove the positive battery terminal.

3. Lift and support the front end of the vehicle using a jack and appropriately load rated jack stands then loosen and remove the lug nuts from both front wheels. Remove the wheels and set them aside.

4. Disconnect the wheel sensor connector in each of the front wheel wells by removing the snap ring.



5. Use a panel puller to remove the 12 body pins and a pair of side cutters to clip the 7 plastic rivets that retain each of the inner fender well liners and remove them.

6. Use a 10mm socket to remove the bolt at the top of each front wheel well.



7. Use a 10mm deep socket to remove the nut inside each of the front wheel wells.



8. Use a 7mm socket and a panel puller to remove the 10 bolts and 3 pins retaining the splash shield to the front lip.



9. Use a 10mm socket to remove the 4 additional bolts retaining the plastic splash shield.

10. Lift the plastic radiator shroud covers from underneath the hood latch and put them aside.



11. Use a panel puller to remove the 4-10 (depending on vehicle) push pins along the top of the front fascia.

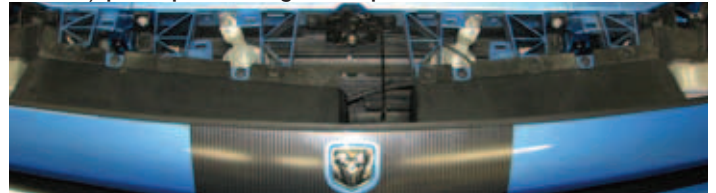

12. Use a 10mm universal socket to remove the bolts at both top corners of the front fascia.



13. Disconnect the fog lamp electrical connectors, if necessary; otherwise just disconnect the lighting harness connector from the main engine harness.

14. Remove front fascia and place aside.



Edelbrock Hemi Supercharger System 2005 - 2010 Dodge/Chrysler Vehicles

Installation Instructions

15. Remove the radiator shrouds.

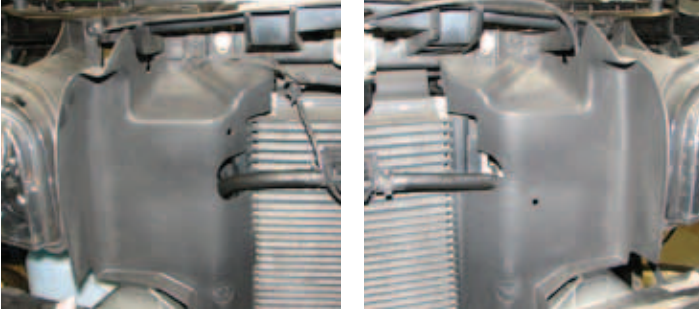

16. Squeeze the clips to detach the transmission cooler (if equipped) from the AC condenser.



17. Use an 8mm socket to remove the 4 bolts supporting the AC condenser then use some mechanic's wire to support the condenser.

18. Place a drain pan below the petcock on the passenger side of the radiator then loosen the petcock and drain the coolant.



19. Use a 10mm socket to remove the two bolts securing the top of the radiator.

20. Disconnect the radiator fan harness connector.

21. Use a 13mm socket to remove the radiator hose housing from the water pump assembly.



22. Use a 10mm socket to remove the bolt that secures the power steering line to the top of the crossmember.

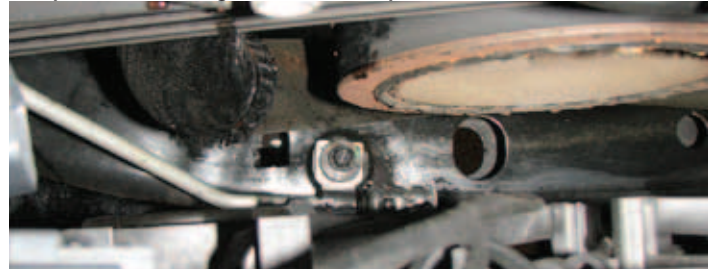

23. Vehicles equipped with a three row transmission cooler should use a 10mm socket to remove the bolt that secures each horn bracket and set the horns aside.



24. Disconnect upper and lower radiator hose from the radiator.



25. Remove lower airbox with 10mm socket to get to the driver side bolts on the radiator saddle.



Edelbrock Hemi Supercharger System 2005 - 2010 Dodge/Chrysler Vehicles

Installation Instructions

26. Use a 13mm socket to remove the four bolts supporting the radiator saddle then lower the radiator, fans and upper hose out of the car as a single assembly.

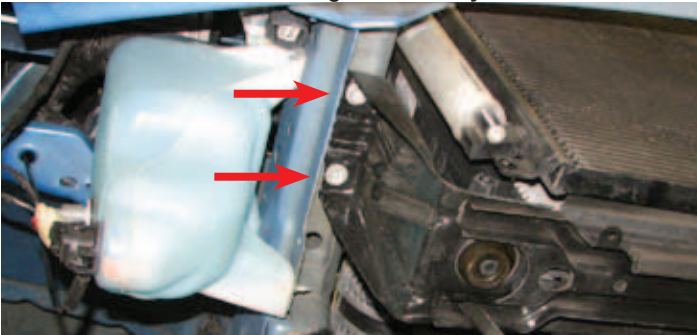

27. Use a 3/8" drive breaker bar to loosen the tensioner and remove the serpentine belt. Check the belt for cracks and replace if necessary. DO NOT discard belt as it will be reused.



28. Use a 21mm socket and an impact gun to remove the crankshaft pulley bolt.



29. Use a pulley puller to pull off the crankshaft damper. Chrysler tool #8513A or equivalent should be used to prevent damage to the end of the crankshaft.

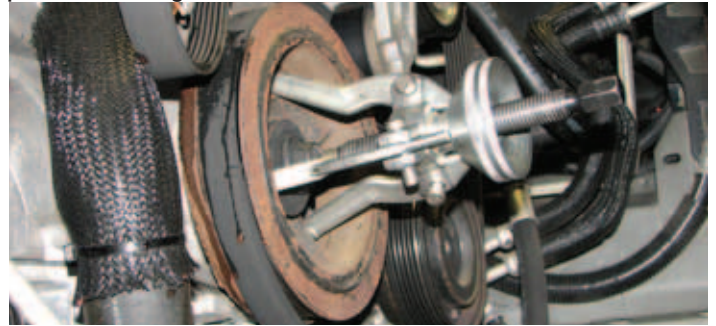

NOTE: Some 5.7L models will require a bolt grip pulley puller for removal. Three (3) long M8 bolts are also required (not included) to thread into the front holes on the damper.



30. Install the supplied drilling guide and rotate it so that you will be able to access the sleeved hole with your drill. Secure the guide with the stock bolt.



31. Use a piece of masking tape to mark the supplied drill bit 1.02" from the end of the tip.

32. Drill through the guide into the crank until the tape mark hits the guide then loosen the crank bolt. Be sure the drill bit does not break through into the counterbore.

33. Use compressed air to clean out the hole just drilled.
CAUTION: Use extreme caution when doing this to make sure no debris gets past the seal into the crankcase, as this



Edelbrock Hemi Supercharger System 2005 - 2010 Dodge/Chrysler Vehicles

Installation Instructions

will require a great deal of disassembly to correct or could cause severe engine damage if ignored. Spin the guide and use the supplied reamer to center the other guide hole on the drilled hole, then tighten down the crank bolt to secure the guide. Use the reamer to ream the hole.

34. Remove the stock crank bolt and the drill guide then clean out the hole in the crank with compressed air.

35. Apply a dab of green Loctite to the supplied crank pin and insert it into the hole in the crank. It might be necessary to turn the engine over to prevent the pin from falling out.



36. Apply a thin layer of engine oil to the end of crankshaft, then install the damper onto the crankshaft. Use Chrysler tool #8512A or equivalent to fully seat damper onto crankshaft. Use caution to avoid damaging the front crank seal during installation, do not apply any lube to front crank seal. The snout of crankshaft pulley and the crank seal should be dry when installed.

37. Once the balancer is fully installed, apply silicone to key way to prevent any oil weeping. Torque the stock crank bolt to 129 ft-lbs.

38. Attach the supercharger pulley to the balancer then apply red Loctite to the bolts and install them using a 1/4" Allen socket. Torque the bolts to 18 ft-lbs in a star pattern.



39. Loosen the worm clamps securing the air inlet tube and use a 10mm socket to remove the bolt securing the stock air box. Disconnect the engine harness from the IAT sensor, then remove the airbox and air inlet tube.



40. Use a 15mm wrench to remove the stud at the top of the water pump and a 13mm socket to remove the two nearby bolts.

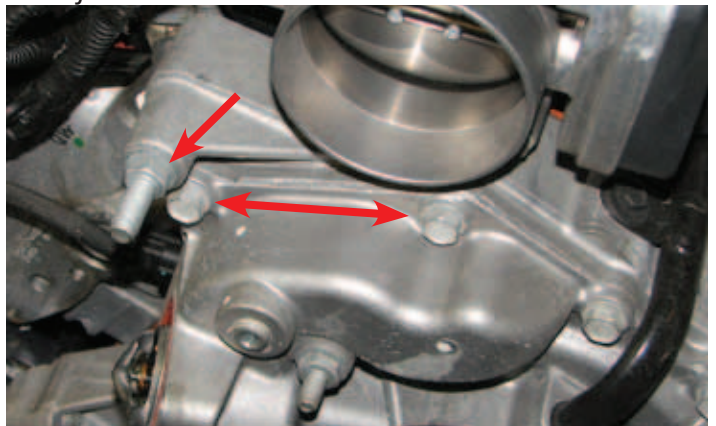

41. Remove the bolt that secures the idler pulley and set the pulley aside for reuse later.



42. Remove the plastic engine covers from the valve covers by lifting them by the ends.



Edelbrock Hemi Supercharger System 2005 - 2010 Dodge/Chrysler Vehicles

Installation Instructions

43. (NOTE: 2006-2008 5.7L Vehicles Only) Use an 8mm socket to remove the two bolts securing the EGR tube, then pull it out of the manifold.



44. Use a 3/8" Fuel Line Removal Tool to disconnect the fuel line from the passenger side fuel rail.



45. Pull the EVAP hose off the nipple on the solenoid.



46. Remove ETC electrical connector from throttle body.



47. Use a 8mm socket to remove the ten manifold bolts.

48. Separate the main wiring harness from the back of the manifold.

49. Pull the manifold forward to gain access to the brake booster hose and pull it off its nipple.

50. The intake manifold can now be removed along with the EVAP hose disconnected from the solenoid earlier.

51. Use a soft cloth to clean the intake flange of the cylinder heads, using caution to make sure that no debris enters the intake ports, then apply strips of masking tape to cover the ports.



52. Use a 10mm socket to remove the two bolts securing each ignition coil, then pull them out. Keep the coils in order so that they can be reinstalled in the same place.

53. Use a 5/8" spark plug socket to remove all 16 spark plugs. Inspect and replace them, as needed, or replace them all with the colder plugs recommended before step 1. Both stock and new plugs should be gapped to .035". Apply a dab of anti-seize to the threads of each plug and install them.

54. Reinstall the ignition coils in the same location they were originally and secure them with the stock bolts.

55. Install the stock serpentine belt in the stock routing configuration, do not tension yet.

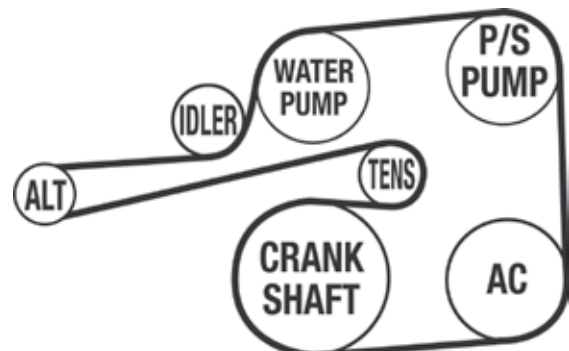



Edelbrock Hemi Supercharger System 2005 - 2010 Dodge/Chrysler Vehicles

Installation Instructions

56. Install the stock idler pulley behind the supplied tensioner bracket with the M10 countersunk bolt supplied in Bag #2, but do not fully tighten it just yet. NOTE: 2009-2010 models will use the smaller M8 countersunk bolt in bag #2.



57. Use the three M8 socket cap bolts supplied in Bag #2 to secure the tensioner bracket. Install the 90mm bolt in the top hole on the driver side and the 40mm bolt on the passenger side, then slide the 75mm bolt into the hole on the tensioner pad and install the supplied M6 nut on the end of the bolt. Use a long Allen tool to tighten the bolts, including the countersunk one previously installed.

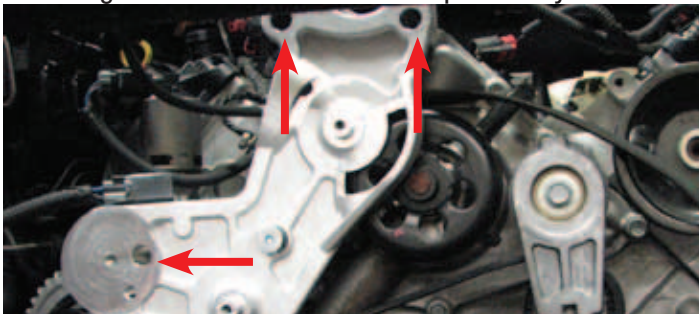

58. Install the supplied idler pulleys onto the tensioner bracket using a 12mm socket, the M8 x 20mm bolts and M8 washers supplied in Bag #2 and a dab of blue Loctite, then torque them to 18 ft-lbs.



59. Install the supplied serpentine belt tensioner onto the tensioner bracket using a 15mm socket, the M10 x 45mm bolt supplied in Bag #2 and a dab of blue Loctite, then torque it to 37 ft-lbs. Once the tensioner has been secured, complete the tensioning of the stock serpentine belt.



60. Loosely install the nose support blocks at the top of the tensioner bracket using the M6 x 20mm socket cap bolts supplied in Bag #2.



61. Use a 5/16" Fuel Line Removal Tool to detach the fuel input line from the factory hard line near the firewall on the passenger side then attach the supplied fuel input line to the hard line.

62. For 6.1L engines, remove the gaskets from the flange of the stock intake manifold then clip off the small plastic locator pins. For '06-'08 5.7L engines, remove the O-ring seals from the flange of the stock intake manifold and trim the tabs, then install them in the grooves on the supercharger flange. Inspect gaskets for damage prior to installation and replace them, if necessary. '09+ 5.7L engines will use the supplied gaskets.



Edelbrock Hemi Supercharger System 2005 - 2010 Dodge/Chrysler Vehicles

Installation Instructions

63. Remove the tape covering the intake ports of the heads and inspect the area to ensure that no residue remains on the flanges. 6.1L and '09+ 5.7L applications should lay the gaskets flat on the intake flanges.



64. With the help of an assistant or a cherry picker, lift the supercharger into the engine bay. Use the intake bolt holes and injector bores to achieve the best alignment possible between the engine and the supercharger.



65. Use a 10mm universal socket to install the eight intake manifold bolts following the sequence shown below, then torque them to 9 ft-lbs in the same order.

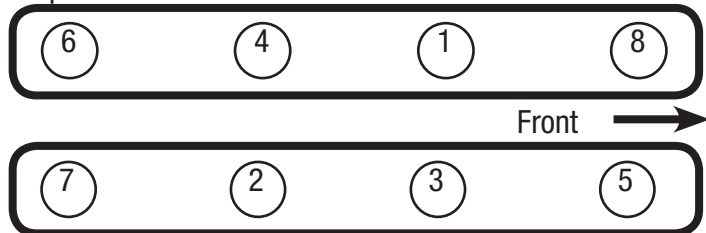

66. Apply a dab of lube to the O-rings of the supplied fuel rail fittings. Install the two straight fittings on the rear provisions of the rails. Install the 180° fitting on the front provision of the passenger side rail and the plug in the front provision of the driver side rail.

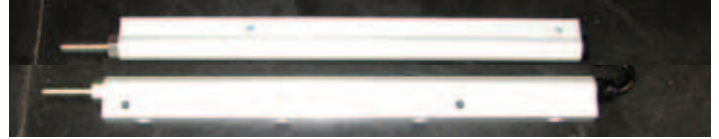

67. Attach the supplied fuel rail crossover line to the straight fitting on the passenger side fuel rail.

68. Apply a dab of lube to the upper O-rings of the supplied fuel injectors, then install them in the fuel rails with the connectors oriented away from the supercharger.

69. Apply a dab of lube to the lower O-rings of the fuel injectors, then install the fuel rails by sliding the injectors down into the manifold provisions and applying pressure until the mounting holes in the rails line up with the manifold. Connect the input line to the 180° fitting on the front of the passenger side rail then route the crossover hose around the fuel input line and behind the manifold as you install the passenger side rail and connect it to the driver side rail.



70. Use a 10mm socket to install the four M6 x 40mm bolts supplied in Bag #1 through the rails to the manifold, then remove the oil fill cap from the stock manifold and install it on the driver side of the supercharger.





Edelbrock Hemi Supercharger System 2005 - 2010 Dodge/Chrysler Vehicles

Installation Instructions

71. Push the nose support blocks tight against the shaft housing and tighten the bolts with a 5mm Allen socket.

72. Attach the supplied brake booster hose to the fitting on the driver side of the air inlet snout, route it along the driver side valve cover and attach it to the brake booster.



73. Install the supplied EVAP hose between the solenoid and the smaller, rear fitting on the passenger side of the air inlet. The end of the hose with a quick disconnect fitting attaches to the air inlet.

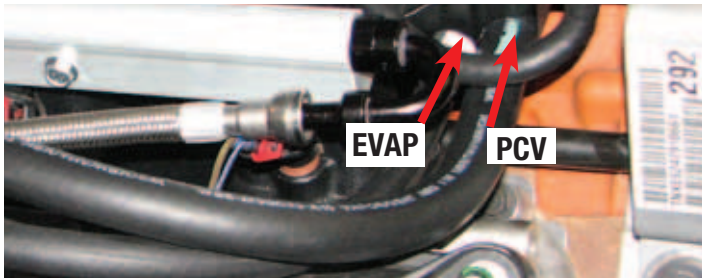

74. If you have a 6.1L engine, remove the PCV valve from the front of the stock manifold, below the throttle body flange; 5.7L applications will use the supplied PCV valve. Thread the PCV valve into the block extending from the passenger side runner of the supercharger then install the supplied passenger side PCV hose between the PCV valve and the larger, front fitting on the passenger side of the air inlet.

75. Install the supercharger drive belt according to the diagram.

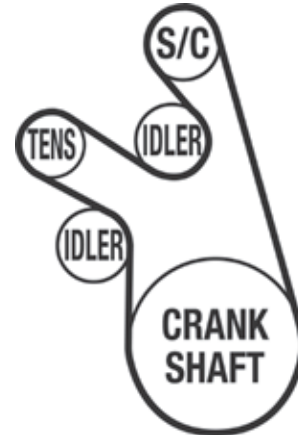

76. Depress the lock tabs and remove the plastic bumper cover, if equipped.



77. Use a 13mm socket to remove the two outboard, passenger side bumper bolts and replace them with the M8 x 30mm bolts supplied in Bag #3.

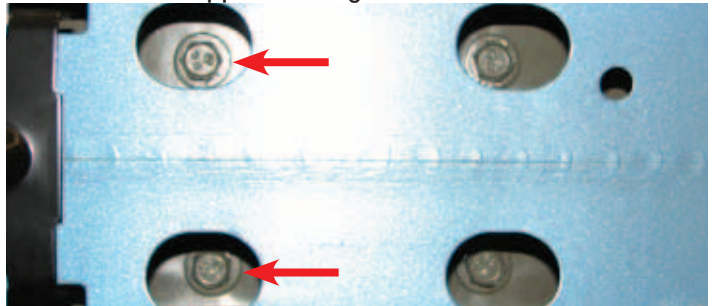

78. Detach the connector from the frame, if equipped.





Edelbrock Hemi Supercharger System 2005 - 2010 Dodge/Chrysler Vehicles

Installation Instructions

79. Loosely assemble the supplied metal strap to the water pump bracket using one of the M8 x 30mm bolts supplied in Bag #3, then mount the water pump bracket on the two new bumper bolts and secure it with the two M8 nuts supplied in Bag #3.



80. With the strap as loose as possible, remove the paper from the foam adhesive and slide the pump into place, oriented so that the inlet will be pointing down and the outlet pointing toward the radiator. Leave a gap between the outlet and the frame to allow the hose to be installed, then tighten the strap bolt.



81. Vehicles equipped with a transmission cooler will need to pull off the retaining discs in order to relocate the cooler support clips to the top row of the condenser. Vehicles equipped with the three row cooler will need to drain the power steering reservoir and install the supplied hose extension on the passenger side using the supplied coupler and clamps.



82. Vehicles equipped with the three row cooler should now reinstall the horns using the supplied brackets.

83. **(NOTE: For Vehicles Equipped w/ Dual Fans, Follow Steps 83-87. For Vehicles Equipped w/ Single Fans, Skip Proceed to Step 88.)** Use an 8mm socket to remove the two bolts securing the radiator fan assembly to the radiator.



84. Disconnect the passenger side radiator fan connector.

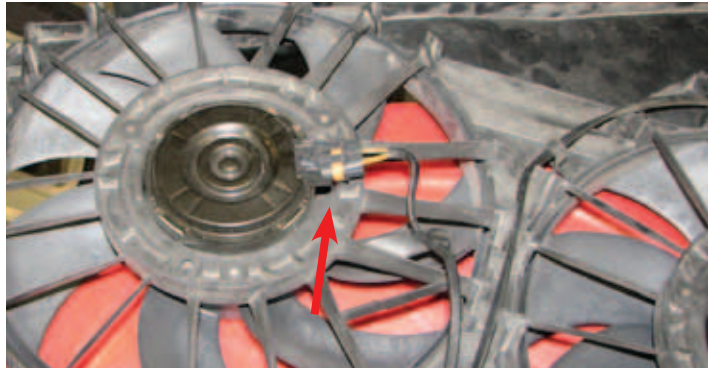



Edelbrock Hemi Supercharger System 2005 - 2010 Dodge/Chrysler Vehicles

Installation Instructions

85. Use a 10mm socket to remove the three bolts securing the passenger side radiator fan motor housing.



86. Rotate the passenger side radiator fan motor housing one bolt hole clockwise so that the electrical connector will face upward, then trim the fan shroud to clear the new harness connector location. Use the stock bolts to secure the fan in its new orientation. Route the wire extending from the connector so that it will not contact the fan blades or serpentine belt when reinstalled.



87. Use the stock bolts to reattach the radiator fan assembly to the radiator then raise the radiator and cradle assembly back into the engine bay and secure it with the stock bolts. Pull the radiator and cradle as far forward as the bolts will allow before tightening them.

88. **(NOTE: For Vehicles Equipped w/ a Single Fan, Follow Steps 88).** Remove (2) top radiator bolts using a 10mm socket, install supplied spacers (2) and new longer M6 x 40mm radiator bolts (2).

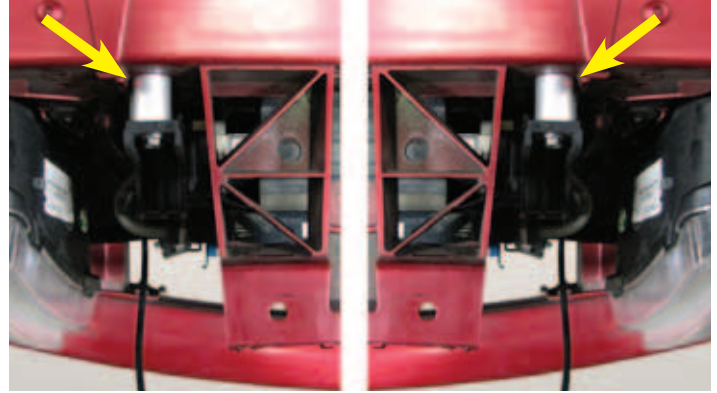

89. Mount the supplied low temperature radiator in front of the AC condenser by lining up the heat exchanger mounting holes over those of the condenser. Vehicles that secure the AC condenser with thread-forming screws going into plastic should reuse those screws, while vehicles using standard machine screws should use the M6 x 25mm bolts supplied in Bag #3. Note that the heat exchanger does not use the upper, driver side location and that the stock bolt should be reinstalled there.

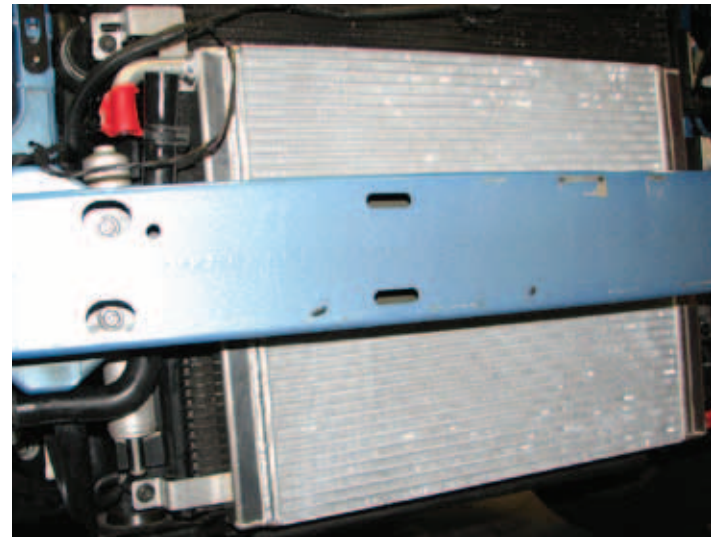

90. Reinstall the bolt that secures the power steering hard line to the crossmember then reattach the radiator fan electrical connector and lower radiator hose.



Edelbrock Hemi Supercharger System 2005 - 2010 Dodge/Chrysler Vehicles

Installation Instructions

91. Install the water pump to heat exchanger hose between the outlet of the water pump and the inlet of the heat exchanger, using a hose clamp to secure each end.

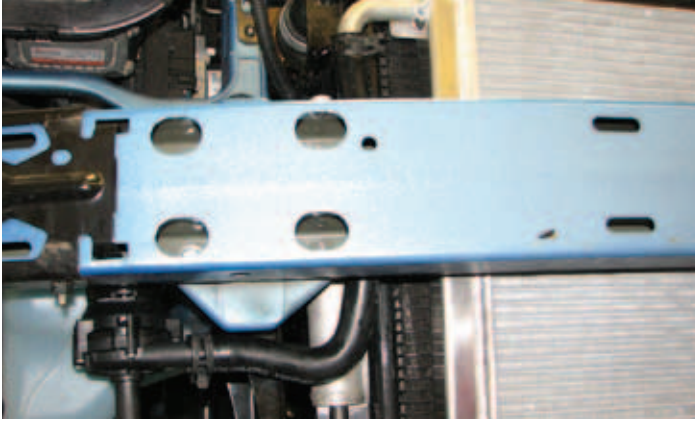

92. Install the long heat exchanger to intercooler hose between the outlet of the heat exchanger and the driver side intercooler fitting on the supercharger. Use caution when routing the hose to ensure it will not contact sharp edges, the exhaust manifold or serpentine belt pulleys.

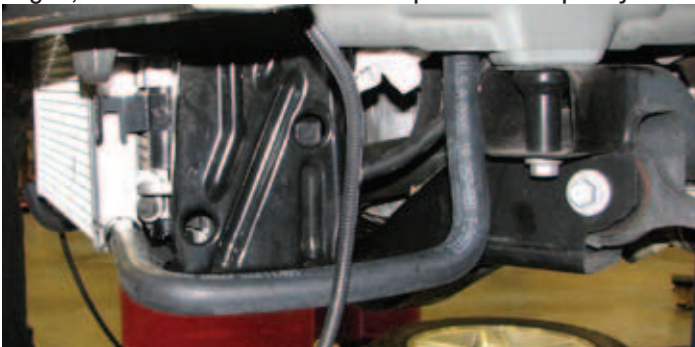

93. Test fit the radiator shrouds and trim them where needed in order to clear the intercooler, power steering cooler and transmission cooler hoses.



94. Use a 13mm socket to remove the two inboard nuts on the passenger side strut tower.



95. Mount the intercooler reservoir to the supplied bracket using the four M6 x 16mm bolts supplied in Bag #3.

96. Attach the reservoir to water pump hose to the bottom provision of the intercooler reservoir and secure it with a clamp, then lower the bracket onto the two inboard strut tower studs on the passenger side but don't fully tighten the nuts. Route the hose down to the inlet of the water pump and secure it with a clamp.



97. Install the Intercooler to Tank hose between the supercharger and tank and secure each end with a clamp.

98. Use an 8mm socket to remove the throttle body from the stock manifold then install it on the air inlet using the factory bolts and the supplied O-ring seal.



Edelbrock Hemi Supercharger System 2005 - 2010 Dodge/Chrysler Vehicles

Installation Instructions

99. If the stock ETC harness is on the passenger side, attach the supplied ETC extension harness to the ETC connector on the main engine wiring harness and route the extension harness under the supercharger drive snout, then connect it to the ETC connector on the throttle body. If the stock harness is on the driver side, simply plug it into the throttle body and discard the supplied extension.



100. Remove the rubber grommet from the bottom of the stock airbox. Install the adapter on the bottom of the supplied airbox using one of the M6 x 16mm bolts supplied in Bag #5. Slide the grommet over the adapter, then thread the supplied bumper into the other provision on the bottom of the airbox.

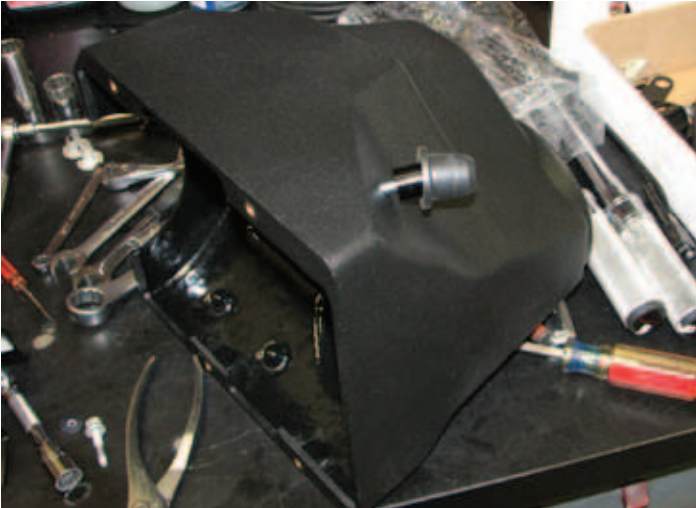

101. Install the air filter onto the air filter adapter using the supplied worm clamp, then install the air filter in the new airbox using two 1/4-20 x 1/2" bolts and attach the bracket using two M6 x 16mm bolts supplied in Bag #5.



102. Remove the rubber grommet from the top of the stock airbox and install it in the new airbox bracket.

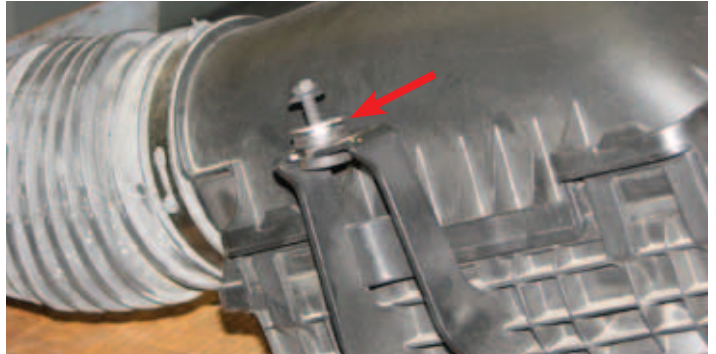

103. Install the new airbox by lining up the bottom grommet with the hole in the fender and applying pressure until it slides into place. Secure the airbox using the stock bolt.

104. Place a worm clamp on each end of the silicone elbow, then install the elbow between the throttle body and air filter adapter. Tighten both worm clamps, then install the airbox cover on the airbox and secure it using the four M6 x 16mm bolts supplied in Bag #5.



Edelbrock Hemi Supercharger System 2005 - 2010 Dodge/Chrysler Vehicles

Installation Instructions

105. Install the driver side PCV hose between the fitting on the runner and the fitting on the elbow.



Open the fuse box and remove the fuse from location 6 (Ignition Coils/Injection 25A - See reverse of fuse box cover), this will be the front most fuse in most applications. Install that fuse in the bottom slot of the supplied fuse tap and the supplied 10 amp fuse in the top slot. Install the fuse tap in the slot previously occupied by the stock fuse.



106. Use a 1/8" bit to drill a hole in the plastic rivet closest to the passenger side strut tower. Feed the bare wire extending from the water pump harness through the hole and insert it into the butt connector on the fuse tap. Crimp the butt connector firmly to secure the connection.



107. Tilt the fuse box up and remove the nut underneath it. Mount the water pump harness relay on the protruding stud and reinstall the nut.



108. Route the water pump connector down to the intercooler water pump and connect it to the pump.

109. Route the power supply wire on the water pump harness over to the power stud on the fuse box. Remove the nut, slide the ring connector over the stud and reinstall the nut. Mount the fuse holder on the stud near the rear of the fuse box.

110. Route the grounding strap on the water pump harness over to the grounding stud on the passenger side strut tower. Remove the nut, slide the ring connector over the stud and reinstall the nut.

111. Install the MAP harness between the stock MAP harness connector and the supercharger MAP sensor.

112. Install the IAT harness between the stock IAT harness connector and the supercharger IAT sensor.

NOTE: There are two supplied IAT harnesses, use the one applicable for your vehicle.

113. Remove the upper alternator bolt and install the cushion clamp, M5 bolt, nut and bracket supplied in Bag #2 so that it will prevent the intercooler reservoir to water pump hose from contacting the serpentine belt pulleys, then reinstall the stock bolt.





Edelbrock Hemi Supercharger System 2005 - 2010 Dodge/Chrysler Vehicles

Installation Instructions

114. Remove the 2nd and 4th upper valve cover studs on each side of the engine and replace them with the studs supplied in Bag #6.

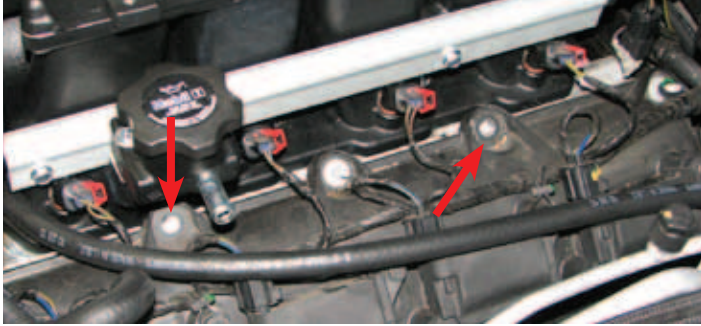

115. Thread the supplied hex bar supports onto the newly installed studs then tighten the stock strut tower nuts securing the intercooler tank.



116. Assemble the grommets and coil cover brackets supplied in Bag #6 then mount the brackets to the underside of the tabs on the supercharger lid. The flat brackets go on the rear provisions while the offset brackets go up front.



117. Thread the ball studs supplied in Bag #6 into the bosses on the underside of the coil covers, then lower the covers onto the engine so that the ball studs slide into the grommets. It may be necessary to re-clock the hose clamps on the intercooler hoses in order to get a flush fit.



118. Attach the bumper cover, then reinstall the front fascia by lifting it into place and lining it up with the guides extending from the front fenders and pushing it into place, pulling the indicator housings through the headlight holes along the way, if needed.

119. Reinstall the stock fascia fasteners. Additional push pins have been supplied in Bag #3 to replace the plastic rivets that were clipped off and stock pins that are easily broken. Specific locations vary by vehicle, but the larger pins are intended for the rivet locations on the front and rear, lower edges of the wheel wells while the smaller ones hold the top of the fender liner and fascia.

120. Reconnect the lighting harness connectors.

121. Remove the intercooler reservoir cap and fill the system with a 50/50 blend of water and antifreeze.

122. Refill the engine cooling system by pouring coolant into the reservoir tank and massaging the lower radiator hose to displace any air pockets in the engine, then use the stock bolts to reattach the upper radiator hose housing to the water pump.

123. Vehicles with a three row transmission cooler that installed an extension hose should check fluid levels and refill the transmission if necessary.



Edelbrock Hemi Supercharger System 2005 - 2010 Dodge/Chrysler Vehicles

Installation Instructions

The Fuel Pump replacement procedure is only for 5.7L vehicles. **Disregard if your vehicle is not a 5.7L.**

NOTE: Before beginning the installation of the supplied fuel pump, make sure the fuel level of the vehicle is below 5/8 of a tank to avoid fuel spillage in vehicle.

The fuel pump module must be installed in the same position as removed. This step must be performed correctly to prevent the float from contacting the side of the fuel tank.

124. Install the supplied fuel pump by removing the rear lower seat cushion. Push the rear lower seat cushion up and back to remove.

125. Fold back the foam pad covering the fuel pump rubber access plug. Remove the rubber access plug using a panel tool and disconnect the electrical connector from the fuel pump module.



NOTE: Prior to removing the fuel pump module, remove any dirt or debris around the fuel tank opening with compressed air.

126. Position the lock ring remover/installer (Chrysler #9340) or equivalent into the notches on the outside edge of the lock ring. Attach a 1/2" drive breaker bar to the lock ring remover/installer and rotate the breaker bar counterclockwise to remove.



127. Lift the fuel pump module up to access the lower power connections. Disconnect the connectors from under the top of the fuel pump module and set aside.



128. Press the quick connect release tab on the fuel supply line and remove. Now, disconnect the lower fuel pump module electrical connector and fuel return lines.

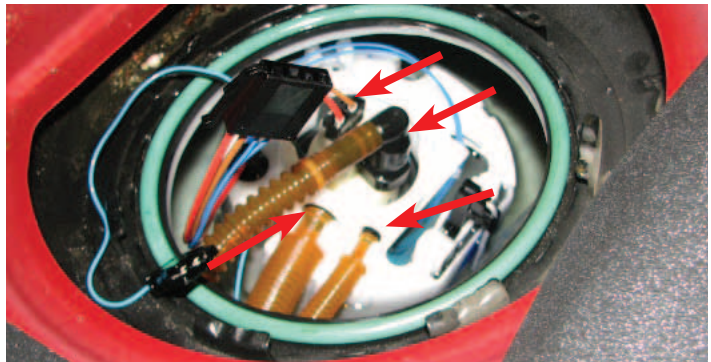

129. Carefully turn the fuel pump module on its side to drain the remaining fuel from the bottom reservoir and remove from the vehicle.

NOTE: An alignment arrow is located on top of the fuel pump module to help align it during installation.

130. Remove the rubber O-ring seal and discard. Replace with the supplied rubber O-ring seal. Then lower the supplied replacement fuel pump module into the fuel tank and connect the fuel return lines.

131. Connect the fuel supply line and lower fuel pump module electrical connector. Now connect the electrical connectors at the top of the fuel pump module and lower the fuel pump module into position.



Edelbrock Hemi Supercharger System 2005 - 2010 Dodge/Chrysler Vehicles

Installation Instructions

132. Position the lock ring over the top of the fuel pump module and rotate the fuel pump module until the embossed alignment arrow points to the center alignment mark.

133. Now, position the lock ring remover/installer onto the lock ring and attach a 1/2" breaker bar. Secure the lock ring in position by rotating the breaker bar clockwise until all seven notches of the lock ring have engaged

If you have yet to flash your ECU, then proceed with steps 135-157, otherwise disregard them.

134. Connect the electrical connector to the fuel pump module and install the rubber access plug and rear lower seat cushion.

135. It is recommended that you check the Edelbrock website (http://www.edelbrock.com/automotive_new/mc/superchargers/fuel_injected_soft-tech.shtml) to confirm that you have the latest calibration. Once you have found the latest tune on the site, power on the programmer, press the left arrow and select the Device Info option. Scroll down to Tune Version and compare that number to the one on the site. If they are different, download the new calibration with the optional USB cable.

NOTE: If you get the message on your Predator programmer that reads: *"This vehicle needs an update Download here: www.diablosport.com/dcx."*, this is because the programmer needs to update the vehicle's stock calibration file because the vehicle currently has an older calibration that is not supported by the programmer, this does not mean that the programmer itself needs an update.

Please go to www.diablosport.com/dcx and it will instruct you how to update the calibration for your vehicle. In order to do this calibration update, you will need a Serial Cable or USB to Serial cable adapter that is not supplied.

136. Plug the supplied programming module into the OBD-II port of the car, located below the steering column.

137. Once the main menu has loaded, press the central 'select' button on the controller to access the 'Performance Tune' option.

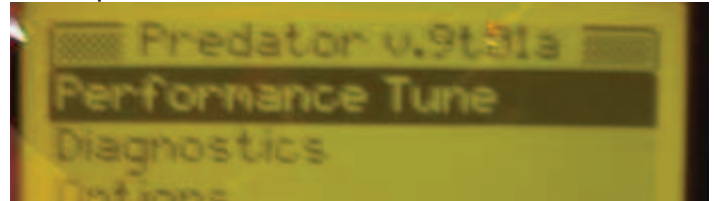

138. Read the disclaimer carefully, then choose 'Agree' and press select.

139. Use the arrow buttons to select your transmission, then press select to confirm your selection.

140. Select 'Edelbrock E-Force 5psi' from the menu.

141. Read the description and press select.

142. The programmer will automatically save a copy of your existing engine tune. Press select to continue.

143. Turn the ignition key to the 'OFF' position when prompted, but do not remove it.

144. Turn the ignition key to the 'ON' position when prompted, but do not attempt to start the car. The programmer will automatically start saving the stock calibration.

145. Once complete, follow the on-screen prompts regarding key position until you are given the option to 'Install Tune' or 'Modify Tune'. Choose 'Modify Tune' and press select.

146. Read the disclaimer and press select.

147. Select 'Modify Parameters' and press select.

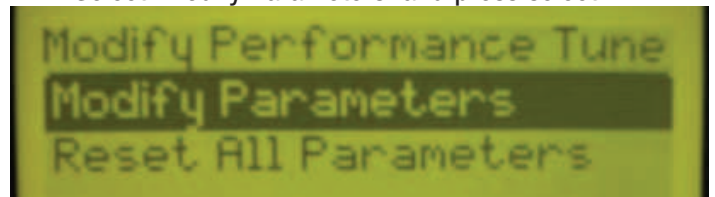

148. Press select to choose 'Axle Ratio'.



Edelbrock Hemi Supercharger System 2005 - 2010 Dodge/Chrysler Vehicles

Installation Instructions

149. Press select to choose 'Axle Ratio', again.

150. Use the directional buttons to choose the number closest to your axle ratio (printed on the differential cover) and press select to confirm your choice.

151. An asterisk will appear next to the 'Axle Ratio' option to signify that your changes have been saved. If your vehicle is equipped with non-stock tires, choose the 'Tire Revs per Mile' option and press select; otherwise, proceed to step 155.

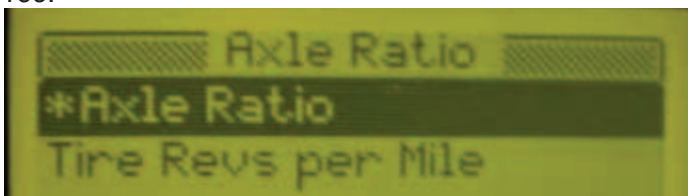

152. You will need to check your tire manufacturer's website to determine the tire revolutions per mile for your tires.

153. Use the directional buttons to select the number closest to the tire revs per mile figure provided by your tire manufacturer. Press select again to confirm your selection.

154. Press escape twice to return to the Performance Tune menu. Choose 'Install Tune' and press select.

155. Confirm your choice by pressing select.

156. Follow the on-screen prompts regarding key position until you receive notification that the tune installation is complete.

157. When the download is complete you will be prompted to disconnect the Diablo Sport Performance Tuner from the OBD-II port of your vehicle.

158. Start the car and allow it to idle while closely inspecting the engine bay for any fuel or coolant leaks. Repair any leaks before operating vehicle!

159. After letting the engine come up to operating temperature, shut it off and recheck all fluid levels, topping them off as necessary.

NOTE: All Hemi kits (except 1532, 15320 and 1533) are equipped with adjustable boost settings. Level 3 being Mild, 2 Normal, 1 Aggressive/Race Only.

160. The supercharger is shipped from the factory with the boost engagement level set to Level 2 (NORMAL boost engagement level).



If you find that the boost engagement level is too aggressive for normal street driving, set the boost engagement level to Level 3/MILD by moving the spring into position "3". Level "1"/Aggressive, should only be used for race and track applications. Make sure engine is cool before making any adjustments.

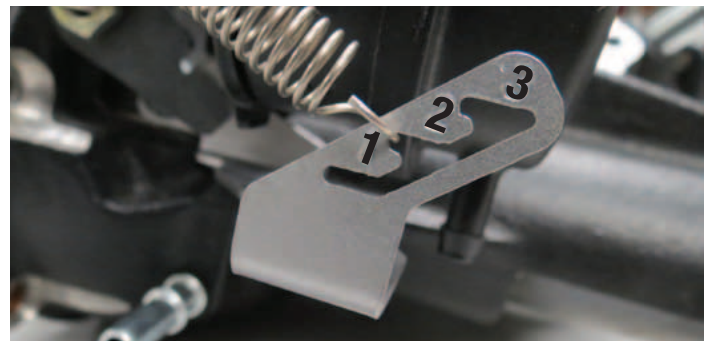

161. The standard Edelbrock calibration is compatible will all three (3) boost engagement level settings. No other calibration is required if no other modifications are made to the engine.

Congratulations on the installation of you new Edelbrock E-Force Supercharger System. If you have any questions, please call our Technical Support hotline at **1-800-416-8628** and one of our technicians will be happy to assist you.



**Edelbrock Hemi Supercharger System
2005 - 2010 Dodge/Chrysler Vehicles**

Installation Instructions



**Edelbrock LLC, 2700 California Street, Torrance, CA 90503
Toll-Free Tech Line: 1-800-416-8628**